



# Crane Copper Tube



**Propress™**  
GAS

**Propress™**  
WATER







## Crane Copper Tube

ABN 51 008 408 151

A Division of  
Crane Enfield Metals  
Pty Limited

PO Box 319,  
Penrith, NSW 2751  
Phone: 02 4720 5350  
Fax: 02 4720 5390  
sales@cranecopper.com.au  
www.cranecopper.com.au

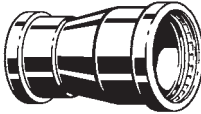
For Viega enquires please call:  
**1800 043 117**

Propress™		GAS		Water		
Description	Size	Product Code	Pack Qty	Product Code	Pack Qty	
Coupling with Stops (No.1) 	DN15	50119364	10	50119457	10	
	DN18	N/A	–	50133582	10	
	DN20	50119388	10	50119458	10	
	DN25	50122662	5	50122415	5	
	DN32	50122663	1	50122416	1	
	DN40	50122664	1	50122420	1	
	DN50	50122665	1	50122422	1	
	DN65	50133533	1	50122423	1	
	DN80	50133534	1	50122424	1	
Reducing Coupling (No.1R) 	DN18x15	N/A	–	50162413	10	
	DN20x18	N/A	–	50162412	10	
	DN20x15	50119408	10	50119459	10	
	DN25x15	50132996	5	50122427	10	
	DN25x20	50122666	10	50122428	10	
	DN32x15	50132997	1	50122429	1	
	DN32x20	50132998	1	50122430	1	
	DN32x25	50122667	1	50122431	1	
	DN40x20	50132999	1	50122432	1	
	DN40x25	50133000	1	50122433	1	
	DN40x32	50122668	1	50122435	1	
	DN50x20	50133001	1	50122436	1	
	DN50x25	50133002	1	50122437	1	
	DN50x32	50133003	1	50122438	1	
	DN50x40	50122669	1	50122439	1	
		DN65x32	50133539	1	50122440	1
		DN65x40	50133540	1	50122441	1
DN65x50		50133541	1	50122442	1	
	DN80x40	50133542	1	50122443	1	
	DN80x50	50133543	1	50122444	1	
	DN80x65	50133544	1	50122445	1	
	DN100x50	50133536	1	50122446	1	
	DN100x65	50133537	1	50122448	1	
Reducer (Reduces a Viega Fitting) 	DN100x80	50133538	1	50122449	1	
	DN20x15	50132991	5	50132889	5	
	DN25x15	50132992	5	50132901	5	
	DN25x20	50132993	5	50132978	5	
	DN32x20	50132994	1	50132979	1	
	DN32x25	50132995	1	50132980	1	
	DN40x20	50160058	1	50160049	1	
	DN40x25	50160059	1	50160050	1	
	DN40x32	50160060	1	50160051	1	
	DN50x25	50160061	1	50160052	1	
	DN50x32	50160062	1	50160053	1	
	DN50x40	50160063	1	50160054	1	
	DN65x40	50133548	1	50133571	1	
	DN65x50	50133549	1	50133572	1	
	DN80x40	50133550	1	50133573	1	
DN80x50	50133551	1	50133574	1		
DN80x65	50133552	1	50133575	1		
DN100x50	50133545	1	50133576	1		
DN100x65	50133546	1	50133577	1		
DN100x80	50133547	1	50133578	1		



# Crane Copper Tube



**Propress™**  
GAS

**Propress™**  
WATER







## Crane Copper Tube

ABN 51 008 408 151

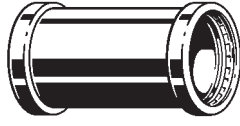
A Division of  
Crane Enfield Metals  
Pty Limited

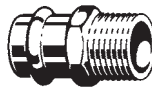
PO Box 319,  
Penrith, NSW 2751  
Phone: 02 4720 5350  
Fax: 02 4720 5390  
sales@cranecopper.com.au  
www.cranecopper.com.au

For Viega enquires please call:  
**1800 043 117**

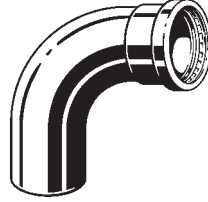
Propress™		GAS		Water	
Description	Size	Product Code	Pack Qty	Product Code	Pack Qty
Repair Coupling (No Stops) 	DN15	50119416	5	50119460	10
	DN20	50119417	5	50119461	10
	DN25	50122670	5	50122454	5
	DN32	50122671	1	50122460	1
	DN40	50122672	1	50122461	1
	DN50	50122673	1	50122462	1
	DN65	50133553	1	50122463	1
	DN80	50133554	1	50122464	1
Female line Adaptor (No.2) 	DN15x1/2"	50119419	10	50119462	10
	DN18x1/2"	N/A	-	50133581	5
	DN20x3/4"	50119423	10	50119463	10
	DN25x1"	50122674	10	50122466	10
	DN32x1/4"	N/A	-	50122467	1
	DN40x1/2"	N/A	-	50122468	1
Male line Adaptor (No.3) 	DN50x2"	N/A	-	50122469	1
	DN15x1/2"	50119428	10	50119464	10
	DN18x1/2"	N/A	-	50133579	5
	DN18x3/4"	N/A	-	50133580	5
	DN20x3/4"	50119434	10	50119465	10
	DN25x1"	50122675	10	50122470	10
	DN32x1 1/4"	50122676	1	50122471	1
	DN40x1 1/2"	50122677	1	50122472	1
	DN50x2"	50122678	1	50122473	1
	Elbow 90° (Female-Female No.12) 	DN15	50119445	10	50119466
DN18		N/A	-	50133583	10
DN20		50119486	10	50119467	10
DN25		50122679	10	50122490	5
DN32		50122680	1	50122491	1
DN40		50122681	1	50122496	1
DN50		50122682	1	50122499	1
	DN65	50133524	1	50122500	1
	DN80	50133525	1	50122502	1
	DN100	50133526	1	50122503	1
Elbow 90° (Male - Female) 	DN15	50119446	10	50119468	10
	DN20	50119447	10	50119469	10
	DN25	50122683	10	50122504	10
	DN32	50122684	1	50122505	1
	DN40	50122685	1	50122506	1
	DN50	50122686	1	50122507	1
	DN65	50133521	1	50122508	1
	DN80	50133522	1	50122509	1
DN100	50133523	1	50122510	1	



# Crane Copper Tube



**Propress™**  
GAS

**Propress™**  
WATER



## Crane Copper Tube

ABN 51 008 408 151

A Division of  
Crane Enfield Metals  
Pty Limited

PO Box 319,  
Penrith, NSW 2751  
Phone: 02 4720 5350  
Fax: 02 4720 5390  
sales@cranecopper.com.au  
www.cranecopper.com.au

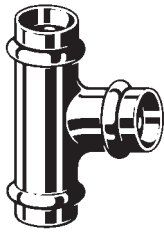
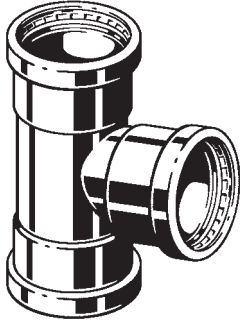
For Viega enquires please call:  
**1800 043 117**

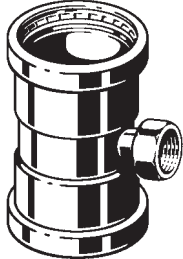
Propress™		GAS		Water	
Description	Size	Product Code	Pack Qty	Product Code	Pack Qty
 <p>Tee &amp; Reducing Tee</p>	DN15	50119448	10	50119470	10
	DN18	N/A	–	50133584	5
	DN20	50119449	10	50119471	10
	DN25	50122687	1	50122585	5
	DN32	50122688	1	50122586	1
	DN40	50122689	1	50122587	1
	DN50	50122690	1	50122588	1
	DN20x15x15	50119450	10	50119472	10
	DN20x20x15	50119451	10	50119473	10
	DN20x15x20	N/A	–	50119475	5
	DN25x25x15	50133004	1	50122589	5
	DN25x25x20	50122691	1	50122590	5
	DN32x32x15	50133005	1	50122591	1
	DN32x32x20	50160057	1	50160048	1
	DN32x32x25	50122692	1	50122593	1
	DN40x40x25	50133006	1	50122594	1
	DN40x40x32	50122693	1	50122595	1
	DN50x50x20	50133007	1	50122596	1
	DN50x50x25	50133008	1	50122597	1
	DN50x50x32	50133009	1	50122599	1
DN50x50x40	50122694	1	50122600	1	
	DN65	50133556	1	50122602	1
	DN80	50133558	1	50122603	1
	DN100	50133561	1	50122604	1
	DN65x65x50	50133557	1	50122608	1
	DN80x80x50	50133559	1	50122611	1
	DN80x80x65	50133560	1	50122612	1
	DN100x100x50	50133562	1	50122613	1
	DN100x100x65	50133563	1	50122614	1
	DN100x100x80	50133564	1	50122615	1
	<p>Tee Adaptor (with Female Thread)</p> 	DN25x25x½"	N/A	–	50122573
DN25x25x¾"		N/A	–	50122574	5
DN32x32x½"		N/A	–	50122575	1
DN32x32x¾"		N/A	–	50122576	1
DN40x40x½"		N/A	–	50122577	1
DN50x50x¾"		N/A	–	50122578	1
	DN65x65x¾"	50133566	1	50122579	1
	DN65x65x2"	50133565	1	50122580	1
	DN80x80x¾"	50133568	1	50122581	1
	DN80x80x2"	50133567	1	50122582	1
	DN100x100x¾"	50133569	1	50122583	1
	DN100x100x2"	50133570	1	50122584	1











## Crane Copper Tube

ABN 51 008 408 151

A Division of  
Crane Enfield Metals  
Pty Limited

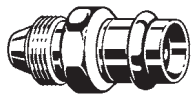
PO Box 319,  
Penrith, NSW 2751  
Phone: 02 4720 5350  
Fax: 02 4720 5390  
sales@cranecopper.com.au  
www.cranecopper.com.au

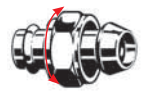
For Viega enquires please call:  
**1800 043 117**

Propress™		GAS		Water	
Description	Size	Product Code	Pack Qty	Product Code	Pack Qty
Elbow 45° (Female - Female) 	DN25	50122695	5	50122616	5
	DN32	50122696	1	50122619	1
	DN40	50122697	1	50122620	1
	DN50	50122698	1	50122621	1
	DN60	50133518	1	50122623	1
	DN80	50133519	1	50122624	1
	DN100	50133520	1	50122625	1
Elbow 45° (Male - Female) 	DN25	50122699	5	50122626	5
	DN32	50122700	1	50122628	1
	DN40	50122701	1	50122630	1
	DN50	50122702	1	50122631	1
	DN65	50133515	1	50122632	1
	DN80	50133516	1	50122634	1
	DN100	50133517	1	50122635	1
Flared Male Adaptor 	DN15x1/2"	N/A	-	50119483	5
	DN20x3/4"	N/A	-	50119484	5
Union (No.62) 	DN15x1/2"	50133014	5	50121369	5
	DN20x1/2"	50133015	5	50132986	5
	DN20x3/4"	50133016	5	50121370	5
Union (Suit Milne TPF Maincock) 	DN20x1"	N/A	-	50159843	5
Union (No.69) 	DN25x1"	50133017	5	50132987	5
	DN32x1 1/4"	50133018	1	50132988	1
	DN40x1 1/2"	50133019	1	50132989	1
	DN50x2"	50133020	1	50132990	1
Male Elbow 	DN20x20	50160056	1	50160047	1



# Crane Copper Tube



**Propress™**  
GAS

**Propress™**  
WATER





## Crane Copper Tube

ABN 51 008 408 151

A Division of  
Crane Enfield Metals  
Pty Limited

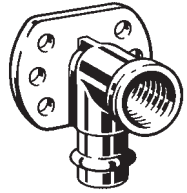
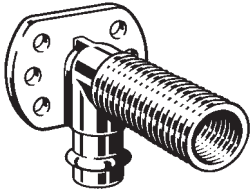
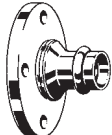
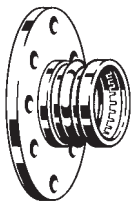
PO Box 319,  
Penrith, NSW 2751  
Phone: 02 4720 5350  
Fax: 02 4720 5390  
sales@cranecopper.com.au  
www.cranecopper.com.au

For Viega enquires please call:  
**1800 043 117**

Propress™		GAS		Water	
Description	Size	Product Code	Pack Qty	Product Code	Pack Qty
Back-plated Female Elbow (15BP) 	DN15x½"	50119452	5	50119476	5
	DN20x¾"	50119453	5	50119477	5
Back-plated Male Elbow (19BP) 	DN15 (½"x75)	50119454	5	50119478	5
Flange (AS2129 Table E) 	DN25	N/A	–	50122646	1
	DN32	N/A	–	50122650	1
	DN40	N/A	–	50122651	1
	DN50	N/A	–	50122652	1
	DN65	50133527	1	50122653	1
	DN80	50133528	1	50122655	1
	DN100	50133529	1	50122656	1
Cap (DN65, 80,100 with Female Thread) 	DN15	50119455	10	50119479	10
	DN20	50119456	10	50119482	10
	DN25	50133010	5	50122637	5
	DN32	50133011	1	50122638	1
	DN40	50133012	1	50122639	1
	DN50	50133013	1	50122640	1
	DN65	50133530	1	50122641	1
	DN80	50133531	1	50122642	1
	DN100	50133532	1	50122644	1
	Gas Installation Caution Tag 	All	50120942	10	N/A



## Crane Copper Tube

ABN 51 008 408 151

A Division of  
Crane Enfield Metals  
Pty Limited



PO Box 319,  
Penrith, NSW 2751  
Phone: 02 4720 5350  
Fax: 02 4720 5390  
sales@cranecopper.com.au  
www.cranecopper.com.au

For Viega enquires please call:  
**1800 043 117**

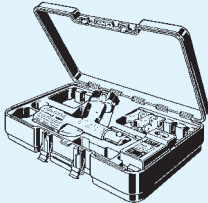
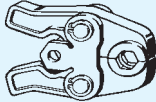
### Propress™ – Picco Series Tools

Description	Size	Product Code
 Pressgun Picco Tool Kit	Pressgun Picco Tool with DN15 & DN20 jaws, 2 x 1.1Ah batteries, charger and carry case	50120476
 Pressing Jaws to suit Picco Series Tools	DN25	50125507

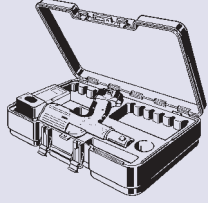
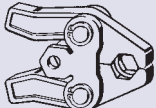
### Propress™ – Pressgun 4B (& PT3) Tools

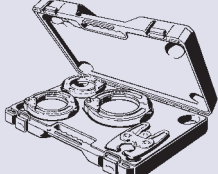
Description	Size	Product Code
 Pressgun 4B with 2 x 2.2Ah batteries, charger and carry case		50133586
 Pressing Jaws to suit 4B & PT3	DN15	50121367
	DN20	50121368
	DN25	50125511
	DN32	50125512
	DN40	50161484
 Set of Jaws DN40 and DN50 in carry case to suit 4B & PT3		50125514
 Set of Jaws DN65, DN80, DN100 in carry case to suit 4B & PT3		50125515



## Crane Copper Tube

ABN 51 008 408 151

A Division of  
Crane Enfield Metals  
Pty Limited



PO Box 319,  
Penrith, NSW 2751  
Phone: 02 4720 5350  
Fax: 02 4720 5390  
sales@cranecopper.com.au  
www.cranecopper.com.au

For Viega enquires please call:  
**1800 043 117**

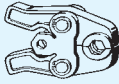
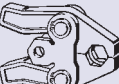
### Specialist Tools – Pressgun Picco/4B

Description	Size	Product Code
Pressing Jaw to suit Picco Series Tools 	DN18 (for water fittings only)	50133585
Pressing Jaw to suit 4B/PT3 Tools 	DN18 (for water fittings only)	50136476

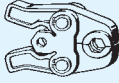
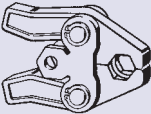
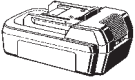
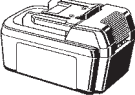
### Replacement Items – Ex Australian Stock

Description	Size	Product Code
Pressing Jaws to suit Picco Series Tools 	DN15	50125505
	DN20	50125506
	DN25	50125507
Pressing Jaws to suit 4B & PT3 	DN15	50121367
	DN20	50121368
	DN25	50125511
	DN32	50125512
	DN40	50161484
	Lithium-ion Battery 18V x 1.1Ah to suit Pressgun Picco/4B tools	50162414
	Lithium-ion Battery 18V x 2.2Ah to suit Pressgun Picco/ 4B tools	50136741
	Battery Charger to suit Lithium-ion batteries from Pressgun 4B & Pressgun Picco	50136740



## Crane Copper Tube



ABN 51 008 408 151

A Division of  
Crane Enfield Metals  
Pty Limited

PO Box 319,  
Penrith, NSW 2751  
Phone: 02 4720 5350  
Fax: 02 4720 5390  
sales@cranecopper.com.au  
www.cranecopper.com.au

For Viega enquires please call:  
**1800 043 117**

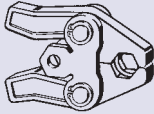
### Replacement Items – Ex Germany

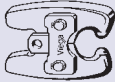
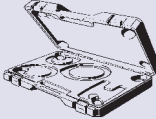
Description	Size	Product Code
Pressing Jaws to suit 4B & PT3 	DN50	50161483
	Carry Case to suit DN40 & DN50 jaws	50161482
XL Jaws 	DN65	50161481
	DN80	50161480
	DN100	50161479
	Actuator for use with XL jaws	50161478
	Carry Case to suit XL jaws & XL Actuator	50161461